

<b>What does dynamics mean?</b>	<b>12</b>
<b>Elevator/Conveying Equipment</b>	<b>12</b>
<b>Dynamic XL Parts</b>	<b>12</b>
<b>Flex-rails</b>	<b>12</b>
<b>Cross-over</b>	<b>12</b>
<b>Catch funnel</b>	<b>12</b>
<b>90° curve</b>	<b>12</b>
<b>Rainbow LED</b>	<b>12</b>
<b>Chain Conveyor</b>	<b>13</b>
<b>Wheel Conveyor</b>	<b>14</b>
<b>Stair Step Conveyor</b>	<b>15</b>
<b>Stage Conveyor</b>	<b>16</b>
<b>Spring Launcher</b>	<b>17</b>
<b>Combination Models</b>	<b>18</b>
<b>Chain Conveyor and Spring Launcher</b>	<b>18</b>
<b>Wheel and Stair Step Conveyor</b>	<b>19</b>
<b>Wheel and Stage Conveyor</b>	<b>19</b>
<b>Other Models</b>	<b>20</b>

## Contents



## What does dynamics mean?

■ We are continuously surrounded by dynamic action. You are even part of dynamic action yourself - regardless of whether you are running, swimming or jumping. As soon as something moves - it is dynamic. Dynamic action means motion upward, downward or to the side. Downward motion is automatic due to the force of gravity. Upward motion requires something like an elevator to overcome the force of gravity.

## Elevator/Conveying Equipment

The PROFI Dynamic XL construction set will allow you to learn a great deal about how balls can be moved upward in different ways. There are different methods for overcoming the force of gravity, from chain conveyors to wheel conveyors and spring launchers.

Naturally with Dynamic XL we don't loose out on the fun going down either. The balls race downward on flex-rails through various obstacles and obstructions such as a stopping point, a cross-over or jump. The balls are continuously transported back up by elevators.

## Dynamic XL Parts

### Flex-rails

#### Tip:

If the rails are bent after disassembly, they can be straightened by clamping them on the base plate for a while. This reduces the bending.

The balls race down the obstacle course on rails. The flex-rails are flexible in all directions. When building an obstacle course you can be as creative as you like and build special, crazy curves, loops and jumps.



### Cross-over

The cross-over is a new component. A lever is attached in the middle of the cross-over to guide the balls alternately to the flex-rail attached on the right or left.

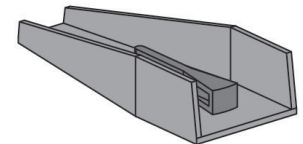

### Catch funnel

This component is used as a catch funnel on various models. For this purpose it is necessary to remove the lever from the cross-over. The wide shape with higher side walls ensures that the balls are caught properly after passing over the jump.

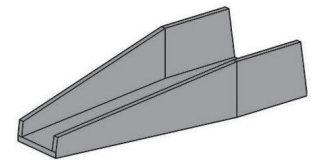

### 90° curve

The 90° curve is an additional, new component in the PROFI Dynamic XL construction set. It allows you to change direction quickly and build tight curves simply.

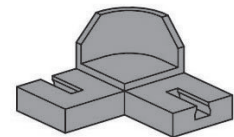

### Rainbow LED

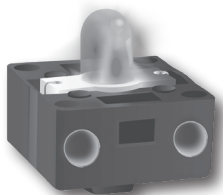

LED's convert the electrical power to light. An LED consists of various semi-conductor materials. The white part of the Rainbow LED has a control chip connected to three light units (red, green and blue). These colors can be mixed to produce other colors. For example mixing green and red produces yellow. The control chip regulates the electrical current. This allows you to adjust the colors to make them light or dark. Actuating the light units one after another from dark to light with a time overlap produces a rainbow and flashing effect. Ensure that you connect the Rainbow LED as shown in the circuit diagram in the assembly instructions. The positive pole is marked red.

■ Chain conveyors are used in highly varying industrial sectors. For example, coal or gravel can be transported with such conveyors. Moreover conveyor belts driven by chains are also available for moving things like pallets or boxes. The chains are driven by an electric motor, just like your Dynamic XL.

On the fischertechnik chain conveyor individual chain links are put together to form a longer chain. A number of magnetic holders are attached to them. As soon as a magnetic holder passes by a ball, it picks up the ball and transports it to the top. After arriving at the top, the ball is stripped off the conveyor and then rolls back down through the obstacle course propelled by the force of gravity.

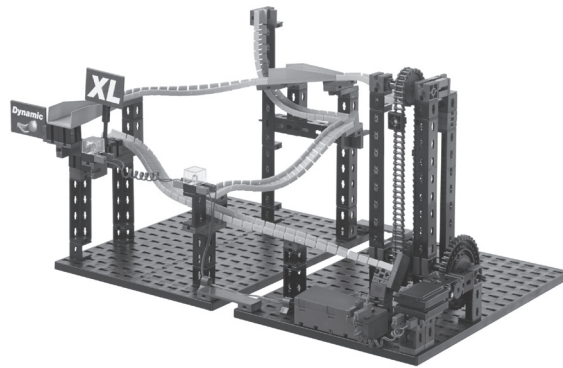

## Chain Conveyor

**Tip:**

If the balls are not picked up properly, you can adjust the position of the rail with the building blocks located beneath it.

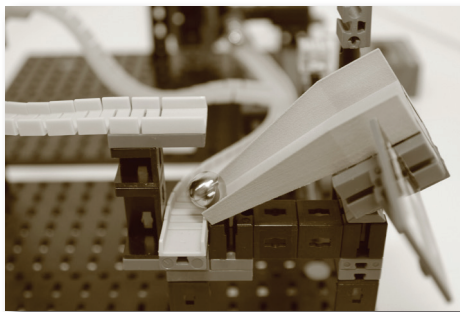

With this obstacle the catch funnel is mounted on pivot block. As soon as a ball rolls from the flex-rail on to the trap door, the weight of the ball causes the part to tilt downward. The ball then continues to roll down the obstacle course on the next flex-rail.

## Obstacle - trap door

**Tip:**

To ensure that the trap door functions properly, it is necessary to ensure that the mounting plate at the side is properly adjusted. Move it to a position where the trap door tilts downward when a ball enters and then tilts back when the ball drops off.

**Task:**

How many balls does the chain conveyor transport to the top per hour?



**Tip:**

Use a stop watch and count the number of balls conveyed to the top in one minute. Multiply this result by the number of minutes in an hour to obtain the number of balls per hour.

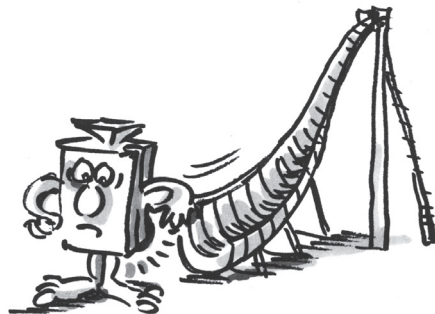

## Wheel Conveyor

■ Have you ever seen a bucket-wheel excavator? Our wheel conveyor can be compared with such a giant construction machine. Various types of raw materials are mined with bucket wheel excavators. The largest of this type are used for mining brown coal. They weigh more than 11,000 cars and are nearly 100 meters high. On bucket wheel excavators the bucket wheel with a number of buckets turns at the very front. The material excavated is then transported upward in a circular path. As soon as a bucket has reached a certain position, the force of gravity causes the material to fall on to a conveyor belt, which transports it on for further processing.

### Tip:

If the balls are not picked up properly or drop off the magnetic holders again right away, readjust the position of the flex-rail.

Our wheel conveyor model operates in a manner similar to a bucket wheel excavator. However the buckets have been replaced by magnets to transport the balls to the top. The lowest flex-rail is installed so that the balls roll up against the wheel conveyor. As soon as a magnetic holder passes by a ball, it picks up the ball and transports it upward in a circular path. After arriving at the top, the balls are stripped off by a plate and start rolling back down.

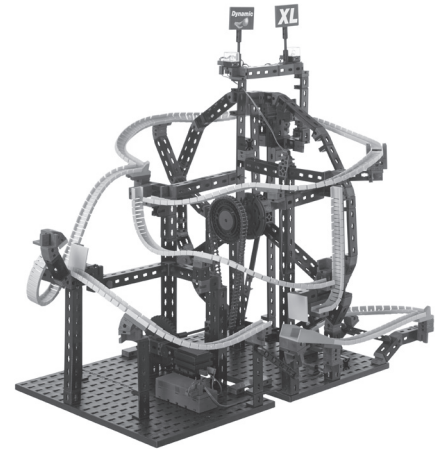

## Obstacle - jump loop

### Tip:

If the ball does not hit the green construction plate precisely, move the building block beneath the looping rail so that the ball hits the construction plate approximately in the middle.

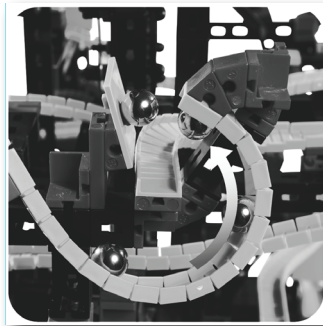

One of the highlights of the wheel conveyor is the jump loop. The ball rolls through the loop, which suddenly ends. The ball flies through the air until it hits the green construction plate. From here the ball travels on to the next rail.

## Obstacle - large jump

### Tip:

If the balls sail past the catch area, you can move the jump rail and building block beneath so that the balls land approximately in the middle of the catch area.

After passing through the jump loop, the ball continues to the large jump in this obstacle course. Just like ski jumpers when ski jumping, the balls fly through the air and land in the catch area of the jump. Then they continue on down to the wheel conveyor.

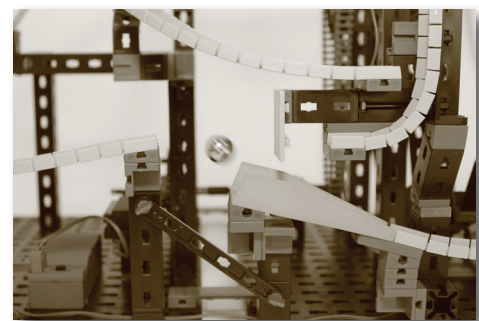



Your ball rolls through the obstacle course - but then the flex-rail stops suddenly and the ball falls downward. The next rail catches the ball and it continues to roll down in the opposite direction.

**Task:**

**Start measuring the time with two balls, one after another and determine which branch from the wheel conveyor is faster.**



■ Stair step conveyors are used in industrial applications for example to transport materials in a machine to another at a higher elevation for further processing, frequently separating them along the way. Here the stair steps move up and down alternately, just like your Dynamic XL stair step conveyor.

The fischertechnik stair step conveyor has five steps, which move up and down uniformly and alternately. Each step is inclined toward the next step, so that the balls roll downwards to the next step. This continues step for step until the balls arrive at the last stair step at the top. From here they then roll down on the flex-rails through the various obstacles in the obstacle course.

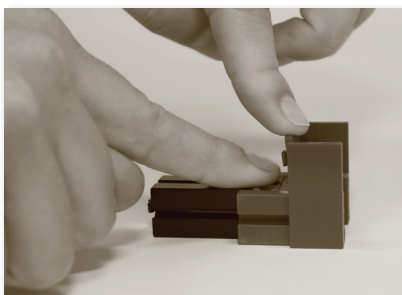

## Obstacle - drop with change of direction

## Stair Step Conveyor

**Tip:**

Do not use more than ten balls in this obstacle course at the beginning.

**Tip:**

To prevent the step components from canting, move the components so that you cannot feel an edge with your finger. For example, press all components down on the table.

**Tip:**

The drive cranks below the steps must be offset precisely 180° for the balls to roll down to the next step without problems. If this is not the case, pull the red idler sprocket off the short shaft. Then you can complete this adjustment easily.

## Obstacle - quarter pipe



### Tip:

Use more than ten balls for this purpose.

For skate boarders or snow boarders a quarter pipe is a construction extending over one-quarter of an arc for performing a variety of tricks. In your Dynamic XL construction set, your balls roll from the flex-rails into a quarter pipe consisting of construction plates. It is inclined slightly toward the front, so that your balls roll up, and are simultaneously guided to the next rail.

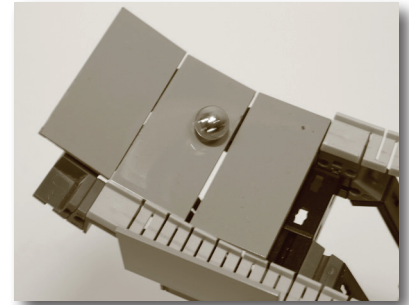

### Task:



**Red construction plates, located on both sides at the end of the last flex-rail in front of the stair step conveyor, extend over the flex-rails. Why do you think these two construction plates are necessary?**

If more than ten balls are used, the pressure on the front balls is so high, that they lift up. Without the two construction plates the balls would probably fall out of the stair step conveyor.

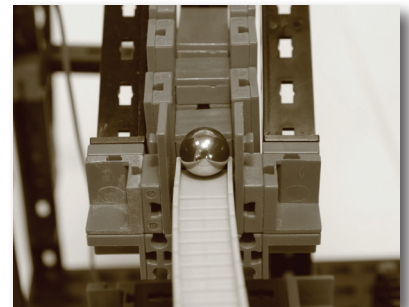

## Stage Conveyor



### Tip:

If the balls do not roll properly to the lowest step on the stage conveyor, you can move the building blocks below the flex-rail to ensure proper transfer in the stage conveyor.

■ Now we will take a little trip to a mine where precisely this conveying technique was used in the past to overcome differences in elevation. This technique is called a "man engine". It was first used in mines in the Harz region of Germany. Here two poles led down into the mine shaft. Steps were fastened to these poles, so that miners could stand on them. The two poles were moved up and down alternately with the aid of a drive mechanism. In the past the entire construction was generally driven by a water wheel. As soon as the steps on the two poles were at the same level, it was necessary for the miner to step over to the other pole. This allowed him to travel up or down the shaft.

The stage conveyor in your fischertechnik PROFI Dynamic XL construction set operates in practically the same manner as the "man engine". The balls roll from one side to the other to the lowest step on the conveyor. The motor and gearbox move the right and left lift rods or poles up and down alternately.

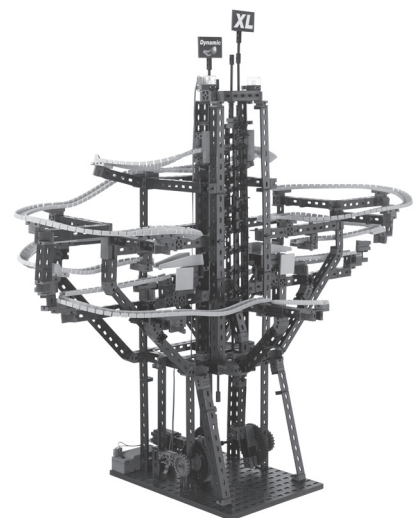

The support surfaces for the balls tilt alternately from side to side. This makes the balls roll from right to left - and vice versa - moving them up step for step. This procedure is repeated until the balls have reached the top step. From here they then shoot back down over the flex-rails.



Push rod      Push rod

**Tip:**

If the balls do not roll over to the other side, adjust the drive shafts so that are offset precisely. When the left push rod is at the lowest point, the right push rod should be adjusted so that it is at the highest point.

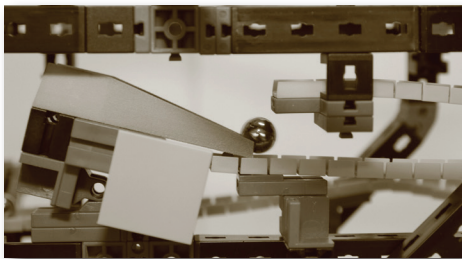

Your stage conveyor has a trap door, which functions in a manner similar to your chain conveyor model.

**Obstacle - trap door**

**Tip:**

See chain conveyor.

The stopping point is an interesting obstacle in this model. Place a ball at the stopping point. When a second ball rolls into the stopping point, it knocks the present ball out. This means the second ball rolling down remains at the stopping point and the previous ball travels on to the next elevator.



**Obstacle - stopping point**

**Tip:**

If the balls start collecting at the stopping point, check whether the supports and components at the stopping point are assembled precisely. Moreover the balls should not be slowed down above the stopping point in the obstacle course. For this reason you should also pay attention to exact assembly here.

**Task:**

**You can see how your ball rolls over the stopping point when another ball is not present in the stopping point. Why is it necessary to first place a ball at the stopping point?**



If a ball is not present at the stopping point, the incoming ball has so much force, that it cannot be stopped by the stopping point. When a ball is in position at the stopping point, it is knocked out of the stopping point by the rolling ball as described.

■ A pinball machine contains a spring launcher which is almost identical to yours. In a pinball machine the ball is brought into play by a spring launcher. The bolt is pulled back and released, so that it hits the ball which rolls into the playing field at high speed.

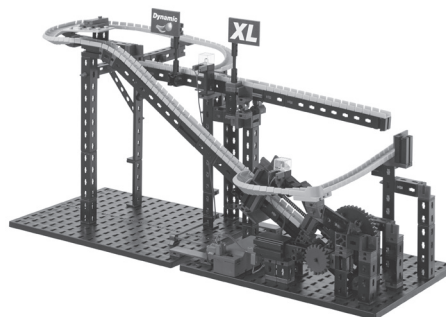

**Spring Launcher**

**Tip:**

A maximum of one ball can be positioned in the spring launcher model.



**Tip:**

If the balls do not reach the top, check the shafts and slides. They should move without friction. If friction is present, your launching ramp is slowed down so that it does not have enough force to catapult the balls all the way up.

**Tip:**

Note that pegs point up on the two building blocks serving as a stop. Otherwise the shaft could slide past the stop and become jammed.

You have installed a bolt to act as the shaft in your spring launcher. Two springs are located around the shaft. Two springs provide a higher force to accelerate your balls more rapidly. Switching on the motor causes a gear to pull the shaft toward the rear, tensioning the springs. As soon as the springs are tensioned completely, the launching mechanism is actuated shooting the ball upward at high speed.

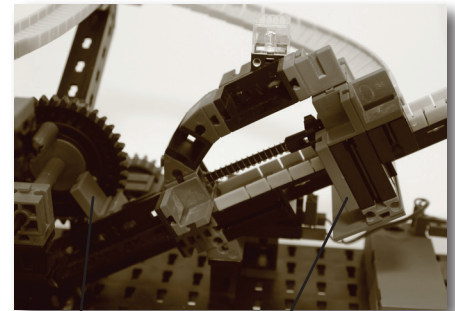

Slides

Stop block

**Obstacle - teeter-totter**



This model includes an additional obstacle, the teeter-totter. A ball rolls on the flex-rails on to the teeter-totter. As soon as a ball has rolled past the fulcrum point on the teeter-totter, it tilts downward. This increases the speed of the ball and at the end of the teeter-totter it falls on to the next flex-rail and continues rolling down through the obstacle course.

**Task:**

**Observe what happens when you continue to move the Dynamic flag on the teeter-totter to the left.**



The further the flag is to the left, the harder it is for the teeter-totter to move down. If you move your flag all the way to the left, the balls are no longer heavy enough to move the teeter-totter all the way down.

**Combination Models**

**Chain Conveyor and Spring Launcher**

**Tip:**

If you have problems with the elevator equipment, help is offered in the tips for the individual models in the activity booklet.

■ This model is a combination of the chain conveyor and spring launcher. However the obstacle course itself has its own specific track shapes and various obstacles. The balls all start on the chain conveyor. It transports the balls part of the way up. After arriving there the balls roll over the flex-rails directly to the spring launcher. The spring launcher then catapults the balls to the larger section of the obstacle course. Here the balls roll through gates and fly over jumps. At the end the balls roll back to the chain conveyor.

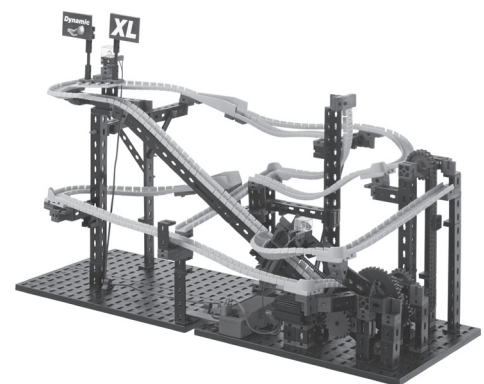



**Task:**

**What is the purpose of the chain conveyor in this model?**



The chain conveyor allows you to use a number of balls in the obstacle course, even though only one ball can be present in the spring launcher at a time.

■ With this model the balls are transported upward by the wheel and stair step conveyors. At the very bottom the balls start with the wheel conveyor. After arriving at the top here, two tracks lead back down. One track terminates at the stair step conveyor. The other track runs through the "drop with change of direction" obstacle twice. At the end all balls roll back to the pick-up point for the wheel conveyor.

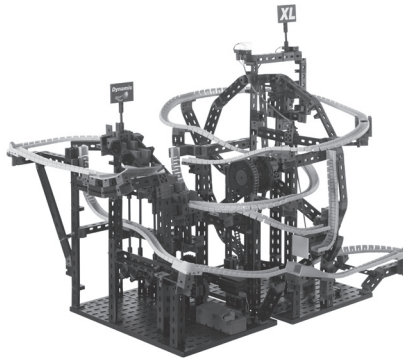

## Wheel and Stair Step Conveyor

**Tip:**

If you have problems with the elevator equipment, help is offered in the tips for the individual models in the activity booklet.

## Wheel and Stage Conveyor

**Tip:**

If you have problems with the elevator equipment, help is offered in the tips for the individual models in the activity booklet.

**Tip:**

Ensure that the joint block is located precisely in the middle of the rocker and that the gate moves easily. Otherwise it may not operate correctly.

## Obstacle - loop

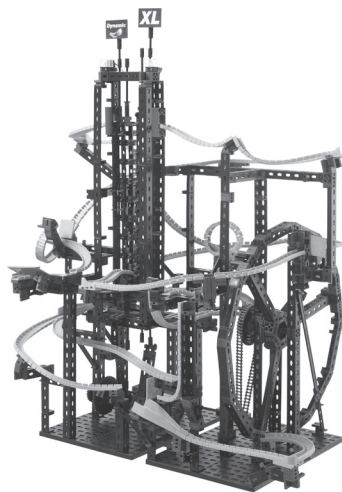

■ This model is the largest of the PROFI Dynamic XL construction set. All flex-rails are installed in the wheel and stage conveyor and the balls run through the most obstacles. The balls also start at the wheel conveyor here. After reaching the top, the balls are stripped off and alternately guided to the left and right by the mechanical "change of direction" switch. Each ball then arrives at one side of the stage conveyor. This elevator then continues to transport the balls upward. After arriving at the top, the balls roll from each exit down the obstacle course on two different tracks.

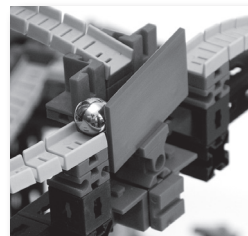

The largest model of this construction set has a highlight: a loop. In front of the loop the balls fall shoot down a nearly vertical track. This gives them enough momentum to fly through the loop. At a lower speed the balls would fall out of the loop. After traveling through the loop the balls hit against a green construction plate and roll on to the next flex-rail.

## Obstacle - small jump

This obstacle is installed only in this model. The balls come directly from the stage conveyor and roll toward the small jump. After arriving here, the balls lift off slightly if you watch closely. They then continue to roll downward on the next flex-rail installed at an angle.



## Obstacle - jump loop

As with the wheel conveyor model, a jump loop is also present here.

### Tip:

See wheel conveyor.

### Tip:

Mark the two balls with different colors.

### Task:

**Observe two balls as they are picked up by the wheel conveyor one after another. Check whether the balls arrive at the wheel conveyor again in the same order, or if the first ball is repeated.**



### Task:

**Again take two balls. It is best to mark one, to keep from mixing them up. Let one ball start rolling down on each side of the stage conveyor. Measure the time required for each ball to arrive at the entrance to the stage conveyor. Which side is faster?**



## Other Models

### Your own Dynamic XL obstacle course

Now it's your turn to be creative. Develop your own obstacle course with fantastic new designs and other exciting obstacles. You can also try to develop completely new conveying techniques to move your balls to the top.

### Combination obstacle course

Maybe you are already the proud owner of an ADVANCED Rolling Action and/or PROFI Dynamic construction set. If so, you can design even larger elevators and, above all, longer tracks, in combination with the parts from these construction sets. Moreover you can think up new, tricky obstacles and effects for your balls to run through on their way down.

Our Internet site at [www.fischertechnik.de/home/downloads/dynamic.aspx](http://www.fischertechnik.de/home/downloads/dynamic.aspx) also provides instructions for constructing an even larger combination Dynamic and Dynamic XL model.

